

WNC SERIES CARTRIDGE CHECK THROTTLE VALVES

WNC- 01 Series

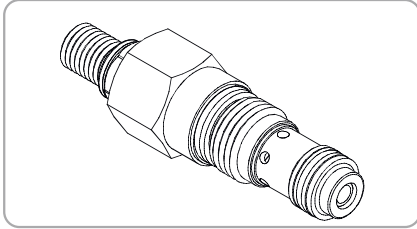

Performance

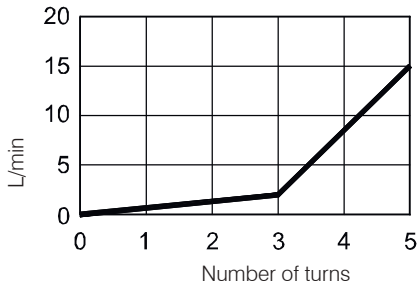

Specifications

Model Number	Max. Pressure (bar)	Flow (lpm)	Weight (Kg)
WNC-01	350 (5076 psi)	15(3.96 gpm)	0.1(0.22 lbs)
Fluid Type		ISO VG 32, 46, 68	
Viscosity cSt		10~400 (59~1854 SSU)	
Operating Temperature		-15~70 (-5~158°F)	
Contamination Level		ISO4406.21/19/16 NAS1638,10	

How To Order

1	2	2
WNC	01	*

1 Valve Series
WNC=Cartridge Check Throttle Valves

2 Subplate Mounting Size
01 :T-162A Cavity :CST-162A

3 Adjustment Option

NONE	NONE:TOOL ADJUST	
K	K:HAND-BAR ADJUST	

Control Port (S)

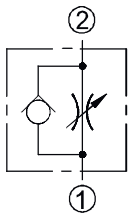

Dimensions

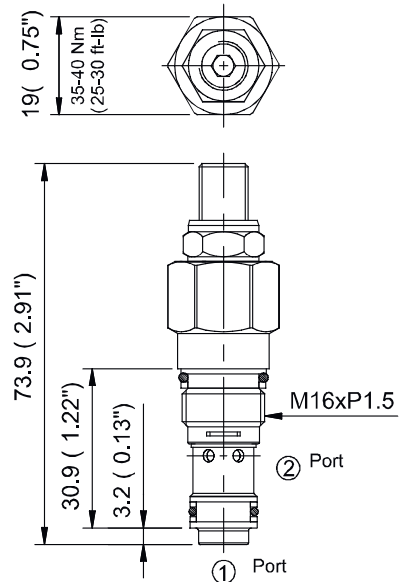

WNC SERIES CARTRIDGE CHECK THROTTLE VALVES

WNC-02 Series

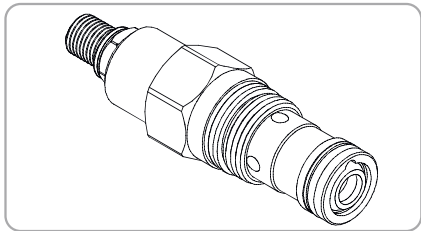

Performance

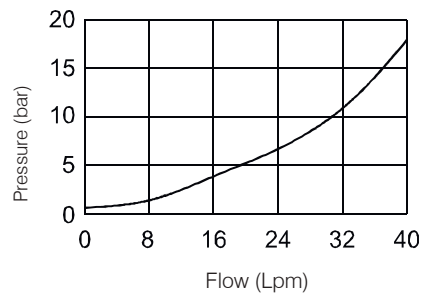

Specifications

Model Number	Max. Pressure (bar)	Flow (lpm)	Weight (Kg)
WNC-02	350 (5076 psi)	40(10.56 gpm)	0.17(0.37 lbs)
Fluid Type		ISO VG 32, 46, 68	
Viscosity cSt		10~400 (59~1854 SSU)	
Operating Temperature		-15~70 (-5~158°F)	
Contamination Level		ISO4406.21/19/16 NAS1638,10	

How To Order

1	2	3
WNC	02	— *

1 Valve Series
WNC=Cartridge Check Throttle Valves

2 Subplate Mounting Size
06:T-13A Cavity CST-13A

3 Adjustment Option

NONE	NONE:TOOL ADJUST	
K	K:HAND-BAR ADJUST	

Control Port (S)

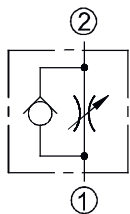

Dimensions

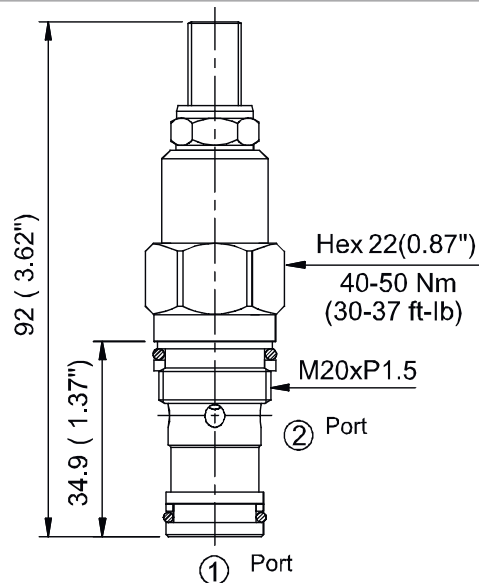

WNC SERIES CARTRIDGE THROTTLE VALVES

WNC - 03 Series

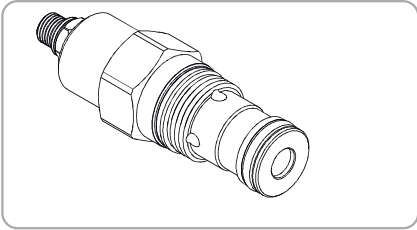

Performance

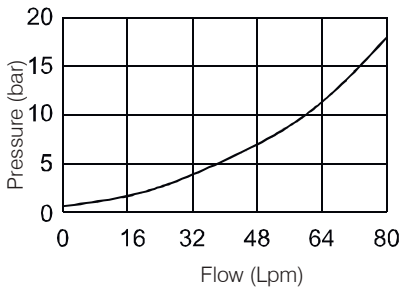

Specifications

Model Number	Max. Pressure (bar)	Flow (lpm)	Weight (Kg)
WNC-03	350 (5076 psi)	80(21.13 gpm)	0.28 (0.15 lbs)
Fluid Type	ISO VG 32, 46, 68		
Viscosity cSt	10~400 (59~1854 SSU)		
Operating Temperature	-15~70 (-5~158°F)		
Contamination Level	ISO4406.21/19/16 NAS1638,10		

How To Order

1	2	3
WNC	03	- *

1 Valve Series
WNC=Cartridge Check Throttle Valves

2 Subplate Mounting Size
01:T-5A Cavity: CST-5A

3 Adjustment Option

NONE	NONE:TOOL ADJUST	
K	K:HAND-BAR ADJUST	

Control Port (S)

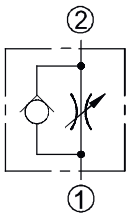

Dimensions

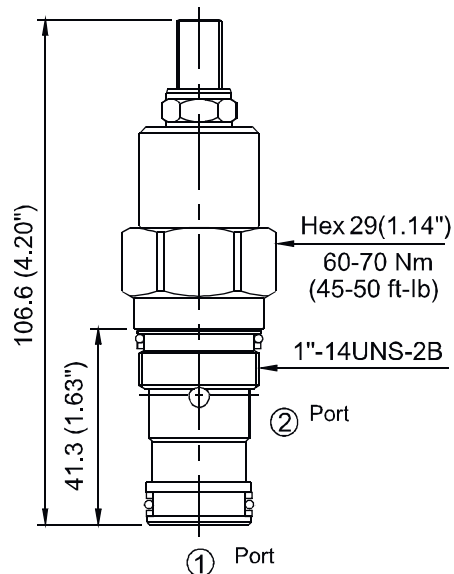

WNC SERIES CARTRIDGE THROTTLE VALVES

WNC - 06 Series

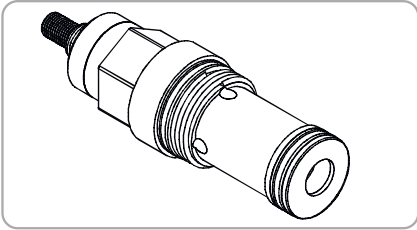

Performance

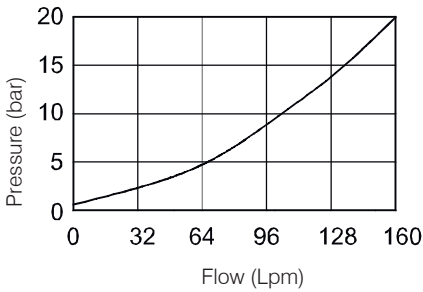

Specifications

Model Number	Max. Pressure (bar)	Flow (lpm)	Weight (Kg)
WNC-06	350 (5076 psi)	160(42.27 gpm)	0.6 (0.32 lbs)
Fluid Type	ISO VG 32, 46, 68		
Viscosity cSt	10~400 (59~1854 SSU)		
Operating Temperature	-15~70 (-5~158°F)		
Contamination Level	ISO4406.21/19/16 NAS1638,10		

How To Order

1	2	3
WNC	06	— *

1 Valve Series

WNC=Cartridge Check Throttle Valves

2 Subplate Mounting Size

01:T-16A Cavity: CST-16A

3 Adjustment Option

NONE	NONE:TOOL ADJUST	
K	K:HAND-BAR ADJUST	

Control Port (S)

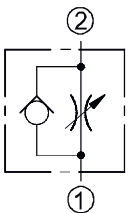

Dimensions

